

BREASEN

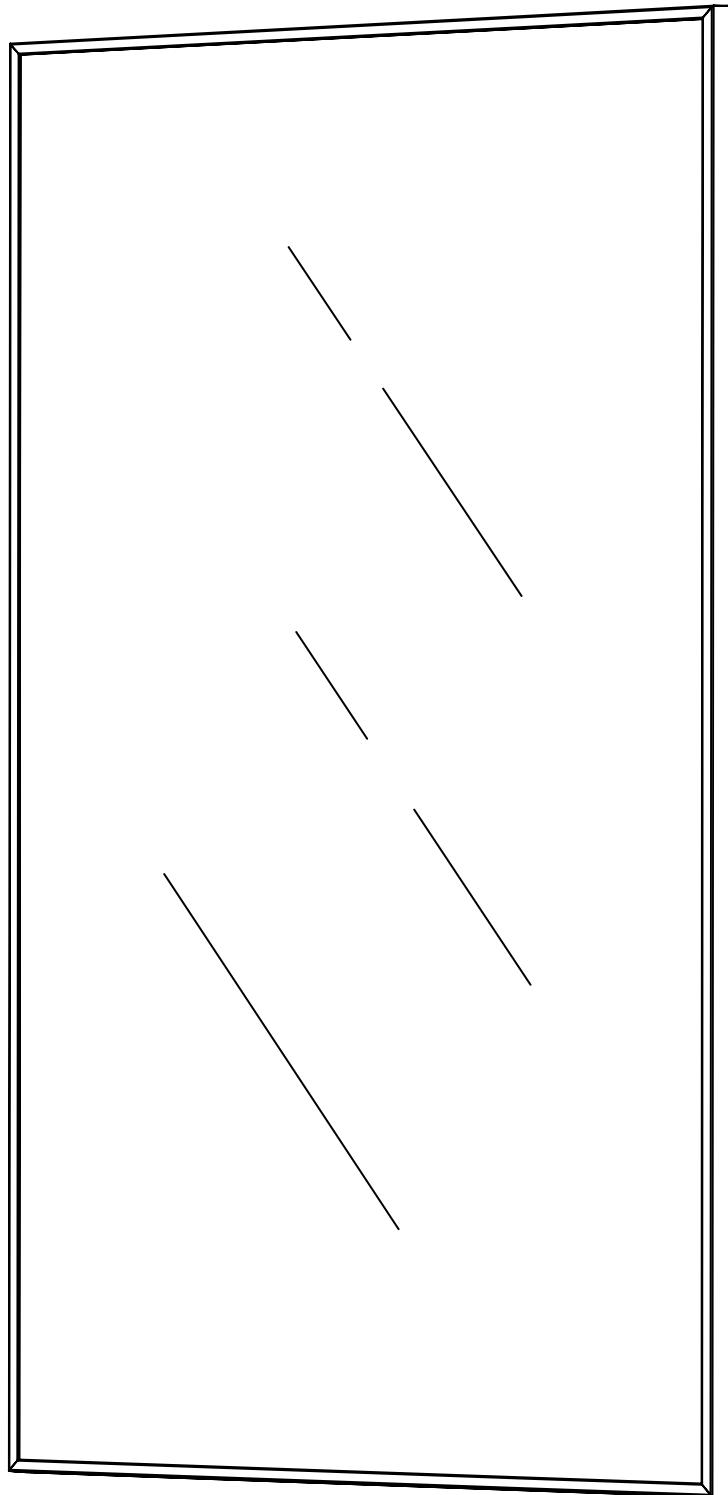

BREASEN ART. NR:

SM2A 4580X450, SM2B 450x800, SM2C 450x1300

VARIANTS VARIANTER

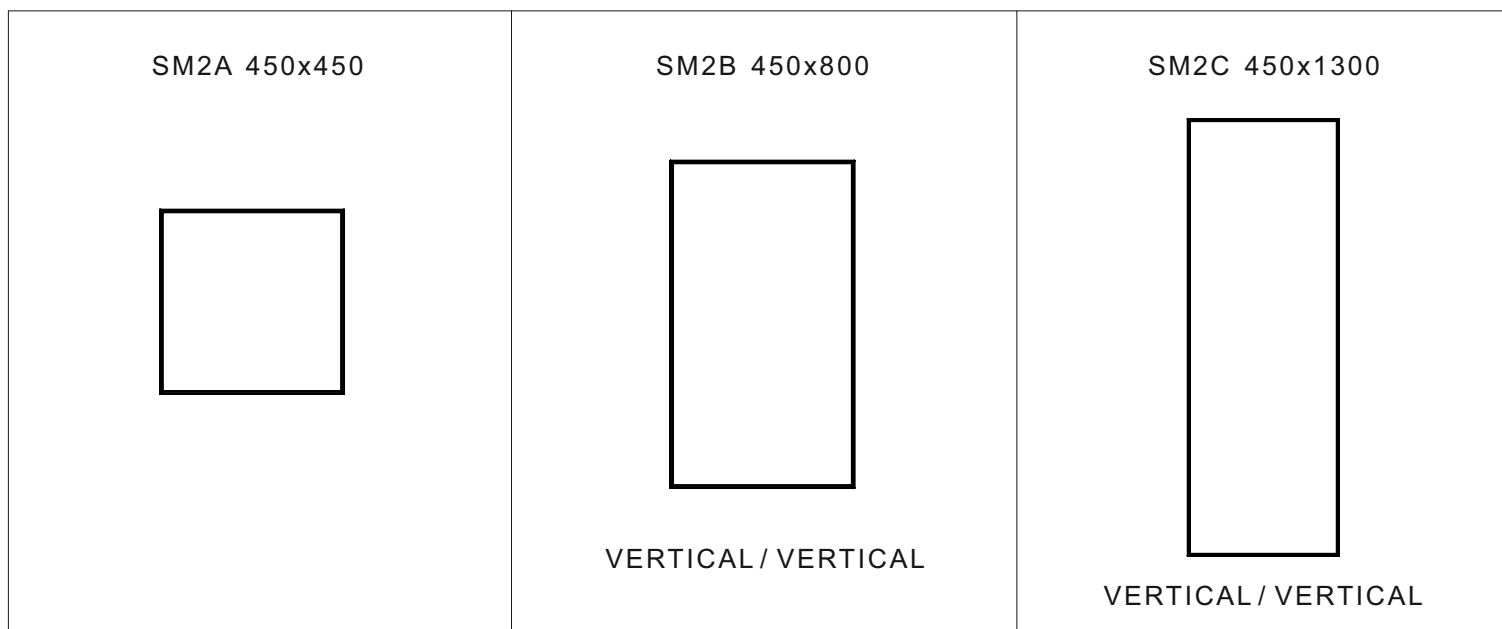

UNPACKING THE MIRROR

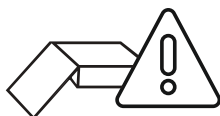

Carefully unpack the mirror.
Do not use sharp tools.
Danger of scratching mirror.
Do not remove protective corners until mirror is mounted

AVEMBALLERING

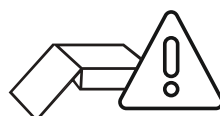

Packa varsamt upp spegeln.
Använd inte vassa föremål.
Vassa föremål riskerar att repa spegeln.
Behåll skyddshörnen på tills upphängning av spegeln skall ske.

PACKAGE CONTENTS

INNEHÅLL

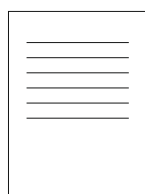

1x



2x

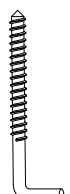

2x
Ø 4x40 mm

WARNING ! check, if this is the correct mounting kit for your wall.
If not, use the correct one.

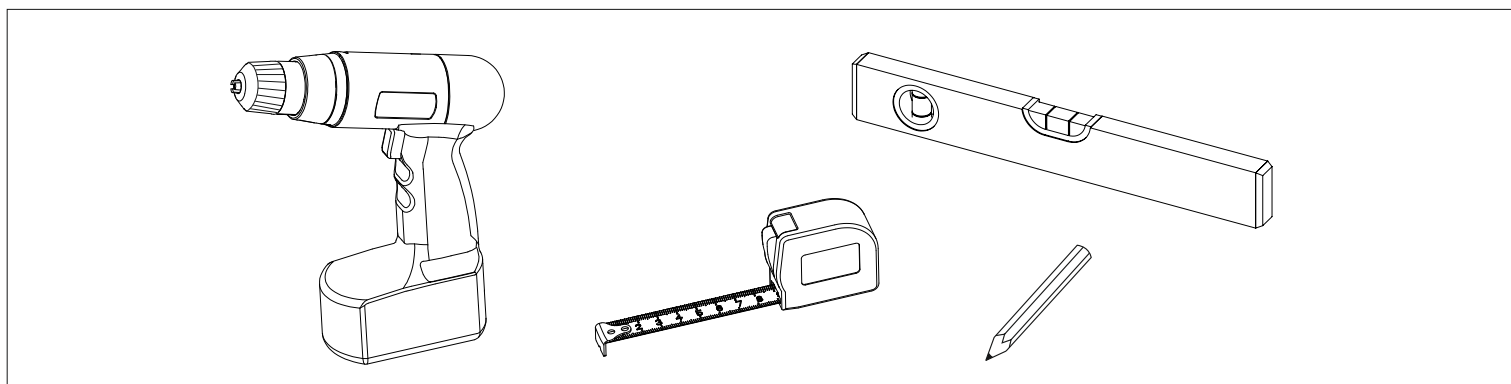

MOUNTING OF MIRROR ON WALL

MONTERING AV SPEGEL PÅ VÄGG

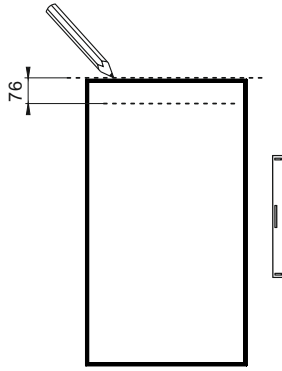

VERTICAL

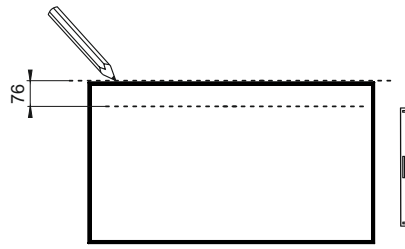

HORIZONTAL

SM2A 450x450

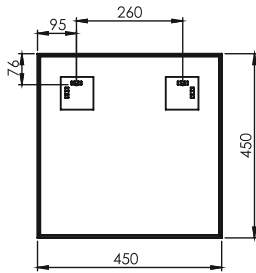

SM2B 450x800

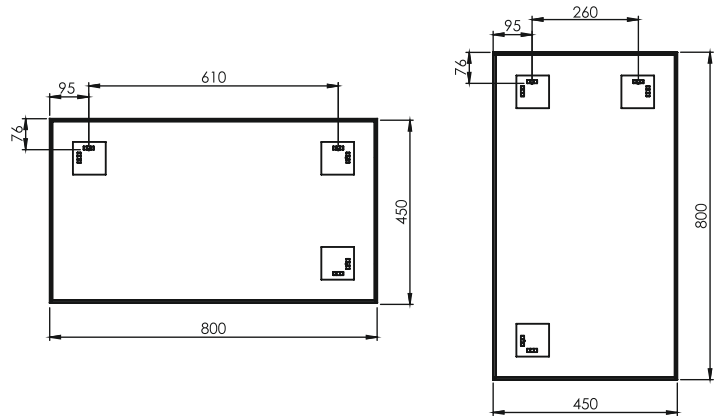

SM2C 450X1300

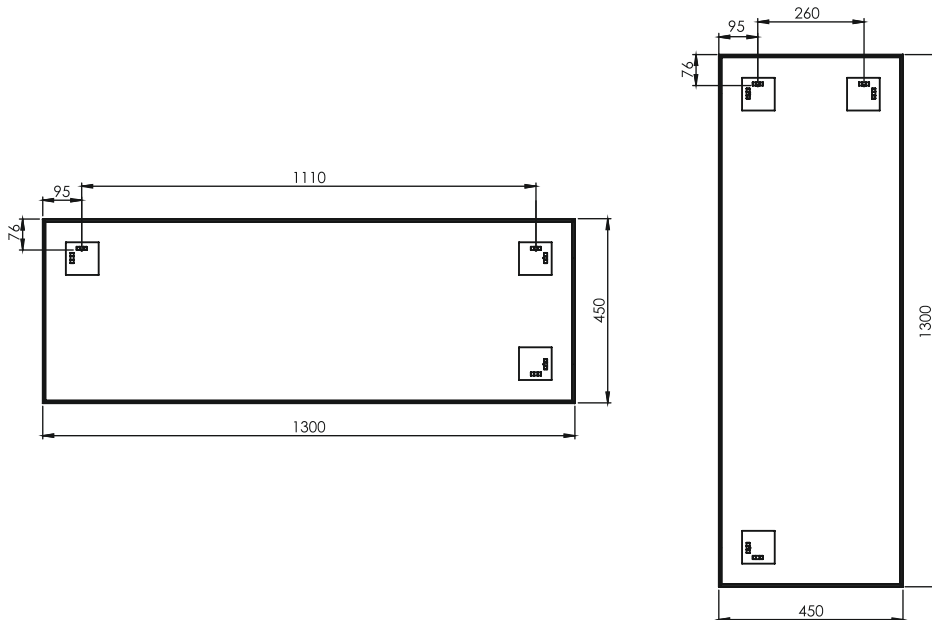

ADJUSTING THE MIRROR

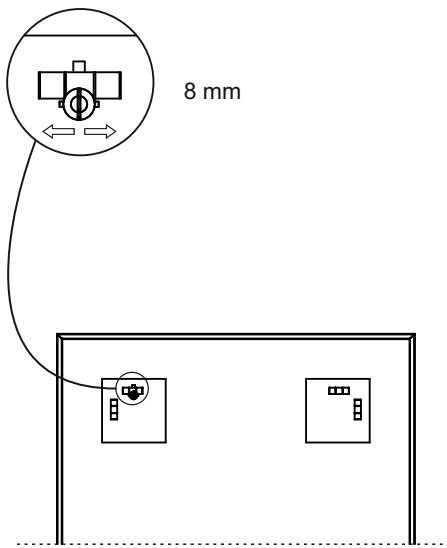

JUSTERINGSMÅN SPEGEL

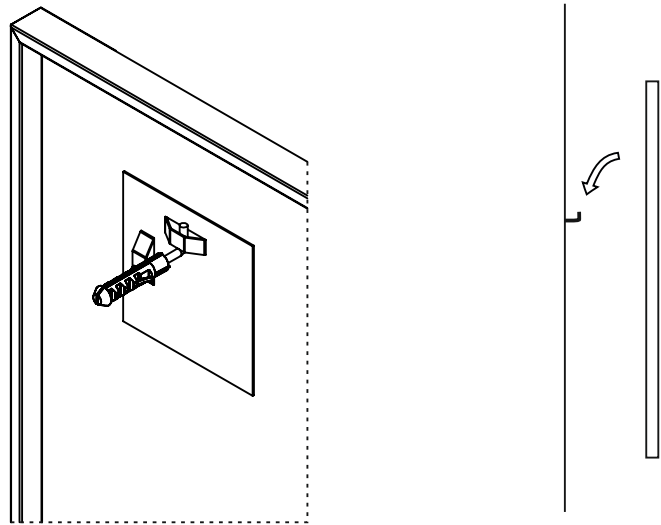

SURFACE CLEANING ADVICE

MIRROR- use lukewarm water or glass /mirror mild cleaner generally available and soft fabric.
METAL- use a soft damp cloth. Avoid detergents.
WOOD- use dry or mild damp cloth.
More information , please visit sesvan.com

RECYCLING

Separate metal , wood and glass for recycling.

WARRANTY

Indoor use only.
Not for wet areas such as sauna, swimming pool,etc. .
See sesvan.com scan QR code

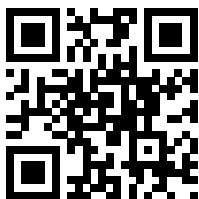

RENGÖRING AV YTAN

MIRROR- användning ljummet vatten eller mild / spegel mild rengöring allmänt tillgängligt och mjukt tyg.
METAL- använd en mjuk fuktig trasa. Undvik tvättmedel.
TRÄ- använd torr eller mild fuktig trasa.
Mer information, [besök sesvan.com](http://sesvan.com)

ÅTERVINNING

Separat metall, trä och glas för återvinning.

GARANTI

Endast inomhusbruk.
Inte för våta områden som bastu, pool osv. .
Se sesvan.com skanna QR-kod